

BETRIEBSANLEITUNG  
OPERATING INSTRUCTIONS  
INSTRUCTIONS DE SERVICE  
ISTRUZIONI D'USO  
HANDLEIDING  
INSTRUCCIONES PARA EL MANEJO  
MANUAL DE INSTRUÇÕES  
NAUDOJIMOSI INSTRUKCIJA  
KASUTUSJUHEND  
LIETOŠANAS INSTRUKCIJA  
DRIFTSINSTRUKS  
DRIFTSINSTRUKTIONER  
DRIFTSVEJLEDNING  
INSTRUKCJA OBSŁUGI

KEZELÉSI ÚTMUTATÓ  
NÁVOD K OBSLUZE  
NAVODILO ZA UPORABO  
NÁVOD NA OBSLUHU  
UPUTE ZA RAD  
MANUAL DE OPERATII  
TREORACHA OIBRIÚCHÁIN  
ΟΔΗΓΙΕΣ ΧΡΗΣΗΣ  
EL KITABI  
ИНСТРУКЦИИ ЗА ЕКСПЛОАТАЦИЯ  
ИНСТРУКЦИЯ ПО ЕКСПЛОАТАЦИИ  
取扱説明書  
사용설명서  
使用说明书

**SV 1100**  
**SV 1101**

**MAKE IT BECKER.**



	<b>AIR</b>	

1

	<table border="1"> <tr><td>Art. No.</td><td>8000308</td></tr> <tr><td>Rev.</td><td>A022462</td></tr> <tr><td>Compressor / Vacuum pump</td><td></td></tr> <tr><td>Year</td><td>000</td></tr> <tr><td>Frequency</td><td>000</td></tr> <tr><td>Speed</td><td>000</td></tr> <tr><td>Pressure/Vacuum</td><td>000</td></tr> <tr><td>Rated capacity</td><td>000</td></tr> <tr><td>Reference</td><td>000</td></tr> <tr><td>Weight</td><td>000</td></tr> </table>	Art. No.	8000308	Rev.	A022462	Compressor / Vacuum pump		Year	000	Frequency	000	Speed	000	Pressure/Vacuum	000	Rated capacity	000	Reference	000	Weight	000	<b>m<sup>3</sup>/h</b> <b>mbar</b>
Art. No.	8000308																					
Rev.	A022462																					
Compressor / Vacuum pump																						
Year	000																					
Frequency	000																					
Speed	000																					
Pressure/Vacuum	000																					
Rated capacity	000																					
Reference	000																					
Weight	000																					
	<b>SV 1100/1 (Pressure)</b> ▶ 50/60 Hz, +175/+150 mbar <b>L<sub>PA</sub> = 74/76 dB(A)</b>																					
DIN EN ISO 11203 Accuracy Class 2 K <sub>son</sub> = 3 dB(A) l ← 1m	<b>SV 1100/1 (Vacuum)</b> ▶ 50/60 Hz, -195/-180 mbar <b>L<sub>PA</sub> = 75/79 dB(A)</b>																					
	<b>SV 1100/2 (Pressure)</b> ▶ 50/60 Hz, +335/+275 mbar <b>L<sub>PA</sub> = 74/80 dB(A)</b>																					
	<b>SV 1100/2 (Vacuum)</b> ▶ 50/60 Hz, -260/-260 mbar <b>L<sub>PA</sub> = 74/78 dB(A)</b>																					

2

static inst. ①-③		dynamic installation Gebr. BECKER
The pump must be securely mounted at the place of installation. Physical tension on the blower housing must be avoided.		
		125-160 kg 276-353 lbs

3

	40°C/104°F -10°C/14°F	H <sub>2</sub> O [g/m <sup>3</sup> ]  max. 90%
<b>INLET AIR</b>	40°C/104°F 0°C/32°F	Temp. [°C]
max. 800m A > 100mm A > 4"		

4

 <b>PRESSURE</b>	optional en option optionale opcional	 <b>VACUUM</b>
	 <b>AIR</b> >100°C >212°F	

5

**Frequency > 60Hz**  
Please consult **BECKER**

<p>50 Hz</p> <p>230/200V 120/200V V Δ / Y</p> <p>15/15/15/15/15/15 A</p> <p>100% F 3000/3000 rpm</p>	<p>60 Hz</p> <p>230/200V 120/200V V Δ / Y</p> <p>15/15/15/15/15/15 A</p> <p>100% F 3000/3000 rpm</p>
--	--

6

**GENERAL**

<sup>1)</sup> motor protection switch ✔

**ADDITIONAL**  $\geq 5.5 \text{ kW}$

**RECOMMENDATION**

**A**

Softstart

**B**

**OPTIONAL**

PTC

ON (I) - 1 2 MAX 10/h

OFF (0) -

7

8

9



**PRESSURE**

**G 4**





**VACUUM**

10

**Maintenance**

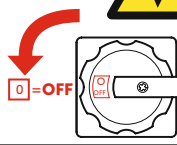
11

**n=0min<sup>-1</sup>**



2-3 Min

12

**CLEANING INTERVAL**



SUCTION AIR

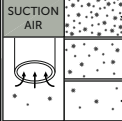

**PRESSURE**

optional  
en option  
optionale  
opcional

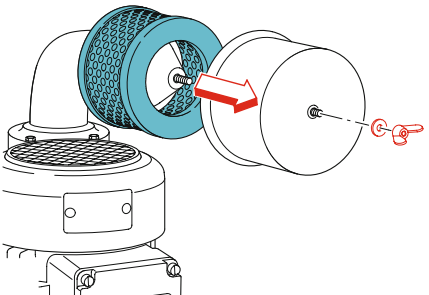

13

**CLEANING INTERVAL**

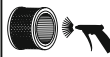

SUCTION AIR

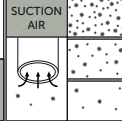

**VACUUM**

optional  
en option  
optionale  
opcional

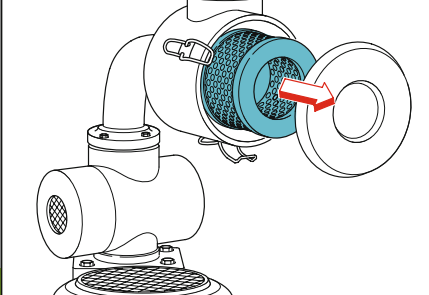

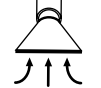
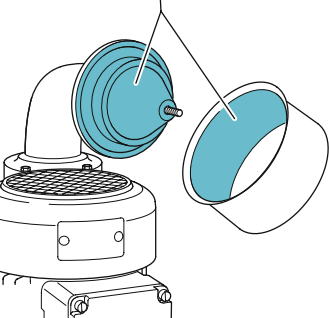

14

**PRESSURE**

15

**VACUUM**

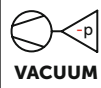
16

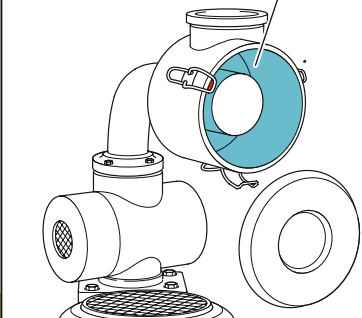
1.	EN149 - FFP3 42 CFR 84 - N100	
2.		

17

18

[www.becker-international.com](http://www.becker-international.com)

19

[WWW.BECKER-INTERNATIONAL-SHOP.COM](http://WWW.BECKER-INTERNATIONAL-SHOP.COM)

Gebr. Becker GmbH  
Hoelker Feld 29-31  
42279 WUPPERTAL  
GERMANY  
[info@becker-international.com](mailto:info@becker-international.com)  
[www.becker-international.com](http://www.becker-international.com)



**MAKE IT BECKER.**

28100060700 | 2021-12-17 | All rights reserved